

M12 SC MALE 90° / M12 FEMALE 90°

FEP-JB bk 1.0m

Male 90° – female 90°

M12 – M12, 4-pole

Stainless steel 1.4305 (V2A) PTFE coated

Art-No. 7005 - M12 Lite - (plastic hexagonal screw) on request

Plastic housings with good resistance against chemicals and oils.

The resistance to aggressive media should be individually tested for your application. Further details on request.

Further cable lengths on request.

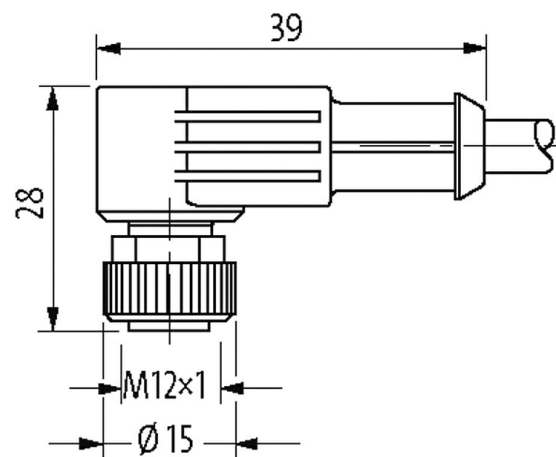
[Link to Product](#)**Illustration**

Product may differ from Image

Form

Form 40268

General data

Pollution Degree	3
Material (gasket)	FKM
Temperature range	-25...+85 °C, depending on cable quality

Cables

Cable number	828
No./diameter of wires	5× AWG 22
Wire isolation	FEP (br, wh, bl, bk, gnye)
Jacket Color	black
Material (jacket)	FEP
Outer Ø	4.3 mm ±5%
Bend radius (moving)	15× outer Ø

Cable identification	828
Approval (cable)	CE
Cable weight [g/m]	40,70
Material (wire)	Cu wire, tin plated
Resistor (core)	max. 52 Ω /km (20 °C)
Single wire \varnothing (core)	0.160 mm
Construction (core)	19× 0.160 mm
Diameter (core)	5× AWG 22
Material (wire isolation)	FEP
Shore hardness (wire isolation)	55 ±5 D
Wire- \varnothing incl. isolation	1.3 mm ±5%
Color/numbering of wires	br, bk, bl, wh, gnye longitudinally striped
Stranding combination	5 wires twisted around central filler
Shield	no
Material (jacket)	FEP
Shore hardness (jacket)	57 ±5 D
Outer- \varnothing (jacket)	4.3 mm ±5%
Color (jacket)	black
chemical resistance	good resistance to oil, gasoline and chemicals (VDE 0472 Teil 803 Test B)
thermal resistance	flame retardant
Nominal voltage	600 V AC
Test voltage	2000 V AC
Current load capacity	to DIN VDE 0298-4
Temperature range (fixed)	-100...+180 °C
Temperature range (mobile)	-100...+180 °C
Bend radius (fixed)	7.5× outer \varnothing
Bend radius (moving)	15× outer \varnothing

Technical Data

Operating voltage	max. 250 V AC/DC
Rated surge voltage	2.5 kV
Operating current per contact	max. 4 A
Material group	IEC 60664-1, category I
Coding	A-coded
Locking of ports	Screw thread (M12×1 mm) recommended torque 0.6 Nm, self-securing
Compression gland	M12 (SW13)
Protection	IP67 inserted and tightened (EN 60529)
Locking material	Stainless steel 1.4305 (V2A) PTFE coated
Material	PUR
suitable for corrugated tube (internal \varnothing)	10 mm

Commercial data

country of origin	DE
customs tariff number	85444290
EAN	4048879487146
eClass	27279218
Packaging unit	1

Sketch

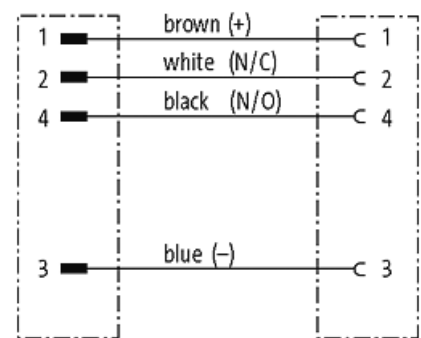
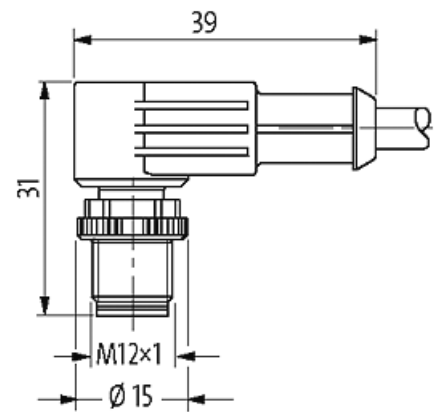

Male

Female

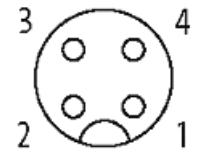
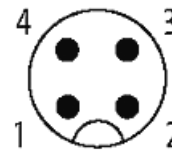

Product may differ from Image